

BLOCO STONE 14

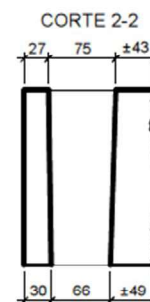

ESPECIFICAÇÕES						
CÓDIGO	Largura (mm)	Altura (mm)	Compr. (mm)	Peso Unit. (Kgf/pc)	f_{bk} (MPa)	Consumo (pc/m ²)
ST1439	±145	190	390	14,0	3,0	12,5
ST1419	±145	190	190	7,3	3,0	25,0
CORES						
Este Bloco de Concreto está disponível nas cores: 00 - Cinza Claro 20 - Amarelo 40 - Ocre 60 - Vermelho 80 - Cinza Escuro						
APLICAÇÕES						
Bloco de Concreto com uma face cisalhada para Alvenarias aparentes de fachadas, interiores, muros, etc.						

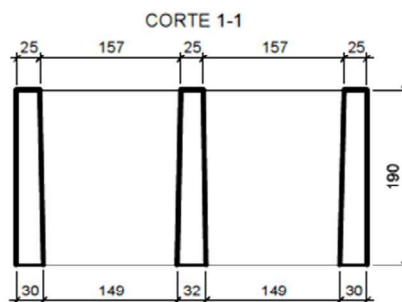
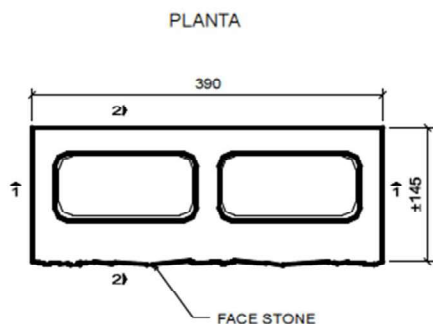
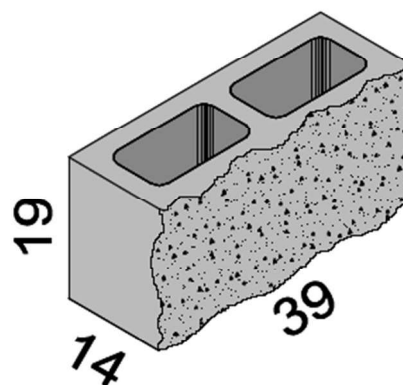

BLOCO STONE 19

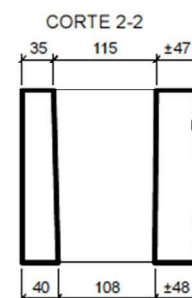
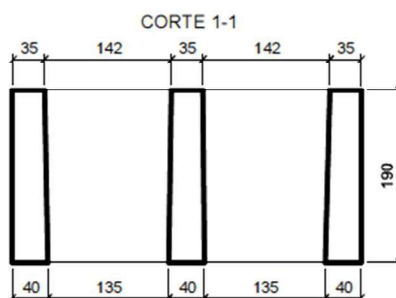
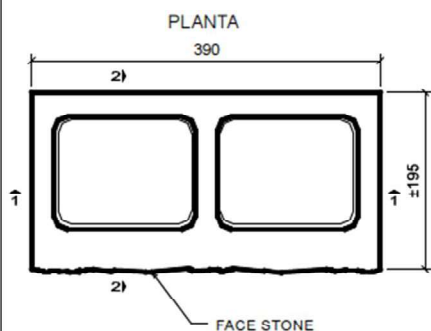

ESPECIFICAÇÕES						
CÓDIGO	Largura (mm)	Altura (mm)	Compr. (mm)	Peso Unit. (Kgf/pc)	f_{bk} (MPa)	Consumo (pc/m ²)
ST1939	±195	190	390	19,2	3,0	12,5
ST1919	±195	190	190	9,6	3,0	25,0
CORES						
Este Bloco de Concreto está disponível nas cores: 00 - Cinza Claro 20 - Amarelo 40 - Ocre 60 - Vermelho 80 - Cinza Escuro						
APLICAÇÕES						
Bloco de Concreto com uma face cisalhada para Alvenarias aparentes de fachadas, interiores, muros, etc.						

